



Version 03

User Manual

HOME-ESS-LV-3.2K

Smart Energy,

Sustainable Solutions

All rights reserved © 2023 Jiangsu Hanchu Energy Technology Co., Ltd

No entity or individual may reproduce or excerpt any part or the entirety of this document without the written permission of our company, and it may not be transmitted in any form.

Trademark Notice

Hanchu ESS and other Hanchu trademarks are the property of Jiangsu Hanchu Energy Technology Co., Ltd.

All other trademarks or registered trademarks mentioned in this document are owned by their respective owners.

Note

The storage, use and disposal of the products shall be carried out in accordance with the user manual, relevant contract or relevant laws and regulations.

The products, services, or features you purchase are subject to the commercial contracts and terms of Jiangsu Hanchu Energy Technology Co., Ltd. All or some of the products, services, or features described in this document may not be within the scope of your purchase or use. Jiangsu Hanchu Energy Technology Co., Ltd makes no express or implied statements or warranties regarding the content of this document.

The content of this document will be periodically updated. You can check the related information on the website of Jiangsu Hanchu Energy Technology Co., Ltd.

Version 01(2023-06-30)

First release.

Version 02(2023-12-08)

Second release.

Version 03(2024-02-20)

Third release.

Contents

1. Manual Overview	1
1.1 Purpose	1
1.2 Target Audience	1
1.3 Symbol Conventions	1
2. Safety Requirements	3
2.1 General Requirements	3
2.2 Personnel Requirements	3
2.3 Installation Environment Requirements	4
2.4 Electrical Requirements	5
2.5 Personal Safety	5
2.6 Battery Safety	6
2.7 Emergency Measures	7
2.8 Battery Recovery Process	8
3. Product Description	9
3.1 Product Description	9
3.2 Interface Description	10
3.3 Symbol Explanation	11
4. Installation	13
4.1 Installation Note	13
4.2 Installation Preparation	15
4.3 Installation	17
4.4 Electrical Connections	18
4.5 Communication Connection	21
4.6 Equipment Debugging	23
4.7 Definition of Indicator Lights	28
5. Common Troubleshooting	30
6. Battery Maintenance	32
6.1 Battery Storage Requirements	32
6.2 Charging Requirements After Over-discharge	32
6.3 Long-term Idle Maintenance Requirements	33
6.4 Battery Maintenance Safety Requirements	33

1 Manual Overview

1.1 Purpose

This document describes the HOME-ESS-LV-3.2K developed by Hanchu ESS in terms of its technical specifications, application scenarios as well as the guidelines for installation, commissioning, maintenance and troubleshooting. Please read this manual carefully, understand the safety information, familiarise yourself with the functions and usage of the battery, and observe the signs on the equipment and all the safety precautions in the manual.

- Please read and understand all the contents of this manual before installing and operating the product. Any damage caused by ignoring the contents of this manual may void the warranty.
- This product can only be used in accordance with the manual, local standards, laws and regulations. Any other use may cause personal injury and property damage.
- The illustrations provided in this manual are used to illustrate product concepts, including product information, installation guidelines, instructions for use, safety information, FAQs, and maintenance, etc.
- Unauthorized changes or modifications to the product are not permitted, any unauthorized changes will void the HOME-ESS-LV-3.2K warranty and Hanchu ESS will not be liable for any damages caused thereby.
- This manual and other product-related manuals are an integral part of the product and need to be kept properly for on-site installation personnel and related technical personnel to consult.

Thank you very much for choosing HOME-ESS-LV-3.2K developed by Hanchu ESS. We sincerely believe that our products can meet your needs and look forward to your feedback.



1.2 Target Audience

This manual is intended for:

- End users
- Installers
- System engineers
- Technical Support Engineers
- End users tasks described in this manual can only be done by qualified electricians.

1.3 Symbol Conventions

Table 1 Meaning of the Identity

Symbol	Description
 DANGER	"DANGER" indicates a hazard with a high level of risks which, if not avoided, could result in death or serious injuries.
 WARNING	"WARNING" indicates a hazard with a medium level of risks which, if not avoided, could result in death or serious injuries.
 ATTENTION	"ATTENTION" indicates a hazard with a low level of risks which, if not avoided, could result in minor or moderate injuries.

The 'DANGER', 'WARNING' and 'ATTENTION' items in the manual do not represent all safety precautions to be followed, but as a supplement to all safety precautions.

Hanchu ESS is not responsible for any of the following situations:

- Operation beyond the conditions specified in this manual.
- Failure to comply with the operating instructions and safety precautions in this manual.
- Installation or use in environments that do not meet relevant international, national or local standards.
- Damage to the battery, dropping, leaking, or damage to the hardware of the device due to improper operation or intentional damage.
- Disassemble and alter equipment or modify software code without authorization.
- Failure to power up the battery in time after the battery installation and connection is completed, resulting in damage to the battery by over-discharge.
- Battery operation and management parameters are set incorrectly.
- The user or a third party uses the battery outside the scenarios specified by us, including but not limited to connecting of excess loads, mixing with batteries with different rated capacities or with other batteries.
- Damage to the battery when the battery's operating environment or external power parameters do not meet the battery's normal operating environment requirements.
- Frequent over-discharge of the battery due to improper maintenance by the user, improper expansion of the battery by the user, or not fully charged for a long time.
- Failure to maintain the battery in accordance with the operating instructions: e.g. failure to check the battery terminals regularly.
- System damages caused by improper operations of a third party or customer, including those in transportation, installation, adjustment, alteration or removal of identification marks.
- The equipment damage caused by abnormal natural environment (force majeure, such as earthquake, fire, storm, flood, mudslide, etc) .
- Damages caused during transportation by the customer.
- Storage conditions do not meet the requirements of the product manual, or failure to charge the battery as required during storage, resulting in loss of capacity or irreversible damage.

2 Safety Requirements

2.1 General Requirements

The equipment has a high voltage. Irregular operation may generate electric shock or fire which may cause death, severe personal injuries or serious property damages. Please standardize the operation :

- It is strictly prohibited to install or operate outdoor equipments and cables (including handling equipment, operating equipment and cables, plugging and unplugging signal interfaces connected to the outdoors, working at heights, outdoor installation, etc.) in severe weather such as thunderstorm, snowy weather, strong breeze.
 - Please observe the operation sequence and safety precautions in this manual and other related manuals.
 - Follow the warning signs, cautions and precautions on the equipment.
 - Follow the manual to use correct tools, and master the correct use of tools.
 - Do not install and connect cables, maintain, or replace equipments with power on.
 - Do not wash the equipment.
 - Do not open the panel of the equipment.
 - Measure the voltage before touching conductor surface or terminal to verify that there is no risk of electric shock.
 - Repair the scratches that occur during equipment transportation and installation in time. It is strictly forbidden to expose the scratched parts to the outdoor environment for a long time.
 - It is forbidden to lift and transport the batteries through the battery terminals or bolts.
 - Do not alter the internal structure or installation procedure of the equipment without prior permission of the manufacturer.
 - Leave the building or the equipment area and turn on the fire alarm or make an emergency call immediately in the case of a fire. Do not enter the building on fire in any case.

2.2 Personnel Requirements

- Personnel installing or maintaining Hanchu ESS equipment must be trained, understand all necessary safety precautions, and be able to correctly perform all operations. Personnel who will operate the equipment, including operators, trained personnel and professionals should possess local national required qualifications in special operations such as high-voltage operations and operations of special equipment.
 - Only qualified professionals or trained personnel are allowed to install, operate and maintain the equipment.
 - Only qualified professionals are allowed to remove security facilities and overhaul equipment.
 - Only professionals or authorized personnel are allowed to replace the equipment or components (including software).
 - ❖ Professionals: personnel who are trained or experienced in equipment operations and are clear of the sources and degree of various potential hazards in equipment installation, operation and maintenance.
 - ❖ Trained personnel: personnel who are technically trained, have required experience, are aware of possible hazards on themselves in certain operations and are able to take protective measures to

minimize the hazards on themselves and other people.

- ❖ Operators: operation personnel who may come into contact with the equipment, except trained personnel and professionals.

2.3 Installation Environment Requirements



- The installation and operating environment must comply with international, national and local standards for lithium batteries and with local laws and regulations.
- Install in a location out of the reach of children.
- Garage installation needs to be far away from the direction of vehicle travel, it is recommended to install the energy storage on the wall above the body bumper to avoid an accidental collision.
- When installing the battery in a basement, keep good ventilation. Do not place flammable or explosive materials around the battery. It is recommended that the battery be mounted on the wall to avoid contacting with water.
- Install the battery in a dry and well-ventilated environment. Secure the battery on a solid and flat surface.
- Install the battery in a sheltered place or install an awning over it to avoid direct sunlight or rain.
- Install the battery in a clean environment that is free from sources of strong infrared radiation, organic solvents, and corrosive gases.
- Precautions should be taken for installation in areas with frequent natural disasters such as floods, mudslides, earthquakes and typhoons.
- Keep the battery away from fire sources. Do not place any flammable or explosive materials around the battery.
- Keep the battery away from water sources such as taps, sewer pipes, and sprinklers to prevent water seepage.
- Do not install the battery in a position where it is easy to touch as the temperature of the chassis and heat sink is high when the battery is running.
- To prevent fire due to high temperature, ensure that the vents and the cooling system are not blocked when the battery is running.
- Do not expose the battery to flammable, explosive gas or smoke. Do not perform any operation on the battery in such an environment.
- Do not install the battery on a moving object, such as ship, train or car.
- Do not install the system outdoors in a salt-affected area because the system may be corroded. A salt-affected area is an area within 500m from the coast or affected by sea breeze. The area affected by the sea breeze varies according to meteorological conditions (such as typhoons and seasonal winds) or topographical conditions (such as DAMS and hills).

2.4 Electrical Requirements

➤ 2.4.1 General Requirements



Before connecting cables, ensure that the product is intact. Otherwise, electric shocks or fire may occur.

- Ensure that all electrical connections comply with local electrical standards.
- Ensure that the cables you prepared meet local regulations.
- Use dedicated insulated tools when performing high-voltage operations.

➤ 2.4.2 DC Operation



Do not connect or disconnect power cables with power-on. Transient contact between the core of the power cable and the conductor will generate electric arcs or sparks, which may cause fire or personal injury.

- Before connecting cables, cut off the power supply if people may contact energized components.
- Please ensure that the label on the power cable is correct before connecting the power cord.
- Disconnect all inputs and operate the equipment only after the equipment is powered off.

➤ 2.4.3 Cabling Requirements



When routing cables, ensure that a distance of at least 30mm exists between the cables and heat-generating components or areas. This prevents damage of the insulation layer of the cables.

When the temperature is low, violent impact or vibration may damage the plastic cable sheathing. To ensure safety, comply with the following requirements:

- ❖ Cables can be laid or installed only when the temperature is higher than 0°C. Handle cables with caution, especially at a low temperature.
- ❖ If the storage environment temperature of the cables is below 0°C, the cables must be stored at room temperature for more than 24 hours before laying the cables.

2.5 Personal Safety



Wear proper personal protective equipment during operation. If there is a probability of personal injury or equipment damage, stop the operations and take feasible protective measures immediately.

- Use tools correctly to avoid hurting people or damaging the equipment.
- The anti-static gloves must be worn when touching the equipment. Do not wear clothes that can easily generate static electricity.
- Do not touch the shell when the equipment is running, the temperature of the shell is high, which may cause burns.
- To ensure personal safety and normal use, it should be grounded reliably before use.
- When the battery is faulty, the temperature may exceed the burn threshold of the touchable surface. Therefore, avoid touching the battery.

- The electrolyte is harmful to your skin and eyes, so do not disassemble or damage the battery and avoid contact with the electrolyte.
- Do not place irrelevant objects on the top of the equipment or insert them into any position of the equipment.
- Do not place flammable objects around the equipment.
- To prevent explosions and body injuries, do not place batteries in a fire.
- Do not place the battery module in water or other liquids.
- Do not short-circuit the battery terminals or it will cause a fire.
- Do not use water to clean electrical components inside or outside of a cabinet.
- Do not stand, rely or sit on the equipment.
- Do not destroy any module of the equipment.
- Batteries may cause electric shocks and high short-circuit currents. When using the battery, pay attention to the following points:
 - a) Remove all metal objects from yourself, such as watches and rings.
 - b) Use tools with insulated handles.
 - c) Wear rubber gloves and boots.
 - d) Do not put tools or metal parts on the top of the battery.
 - e) Disconnect the charging power supply before connecting or disconnecting the battery terminal.
 - f) Determine if the battery is unexpectedly grounded. Please remove power from the ground if accidental grounding occurs.

➤ 2.6 Battery Safety



Do not expose batteries at high temperatures or around heat-generating sources, such as sunlight, fire sources, transformers and heaters. The battery may cause a fire if overheated.

- To avoid leakage, overheating or fire, do not disassemble, alter or damage batteries, do not insert foreign objects into batteries or place batteries in water or other liquids.
- The fire hazard of the lithium-ion battery energy storage system is high. Consider the following safety risks before handling batteries:
 - ❖ Battery electrolytes can be combustible, toxic and volatile.
 - ❖ Battery thermal runaway can generate flammable gas and harmful gas such as CO and HF.
 - ❖ The excessive concentration of flammable gas generated from battery thermal runaway may cause combustion and explosion.
- The batteries must be stored separately inside the packaging. Do not store batteries together with other materials or in the open air. Do not stack batteries too high.
- Do not use batteries beyond the warranty period.
- Do not remove the battery packaging before use. Batteries should be charged during storage by professionals as required. Put batteries back into their packaging after charging during storage.
- Move batteries in the correct direction. Do not place a battery upside down or tilt it.
- Protect batteries from impact.

- Do not perform welding or grinding work around batteries to prevent fire caused by electric sparks or arcs.
- Use batteries within the temperature range specified in this manual.
- Do not use damaged batteries (such as damages caused when a battery is dropped, bumped or dented on the enclosure). Damaged batteries may release flammable gases. Do not store damaged batteries near undamaged products.
- Do not place damaged batteries in close proximity to flammable materials.
- Monitor damaged batteries during storage for signs of smoke, flammable electrolyte leakage, or heat.

2.7 Emergency Measures



➤ 2.7.1 Damaged Battery

- If the battery is damaged or flooded, it may leak the electrolyte and cause a short circuit fire.
- If the battery is wet or immersed in the water, do not try to touch it.
- If the battery seems to be damaged, they are not suitable for use and may be dangerous to persons or property.
- Avoid touching the leaked liquids or gases in the case of battery leakage or abnormal odor, do not approach the battery and contact professionals immediately. Professionals must wear safety goggles, rubber gloves, gas masks, and protective clothing.
- Electrolyte is corrosive and can cause irritation and chemical burns. In case of direct contact with the battery electrolyte, do as follows:
 - ❖ Inhalation: Evacuate contaminated areas, get fresh air immediately and seek immediate medical attention.
 - ❖ Eye contact: Immediately flush your eyes with water for at least 15 minutes, do not rub your eyes and seek medical attention immediately.
 - ❖ Skin contact: Wash the affected areas immediately with soap and water and seek medical attention immediately.
 - ❖ Ingestion: Seek immediate medical assistance.

➤ 2.7.2 Battery Drop Emergency Measures

- If a battery is dropped or violently impacted during installation, internal damage may occur. Do not use such batteries. Otherwise, safety risks such as cell leakage and electric shock may arise.
- If a dropped battery has obvious damage or abnormal odor, smoke or fire occurs, evacuate the personnel immediately, call emergency services, and contact professionals. Professionals can use fire extinguishing facilities to extinguish the fire under safety protection.
- If a dropped battery has no obvious deformation or damage and no abnormal odor, smoke or fire occurs, contact professionals to transfer the battery to an open and safe place or contact a recycling company for disposal.

➤ 2.7.3 Fire Emergency Measures

- If a fire occurs, power off the system if it is safe to do so.
- Use carbon dioxide, FM-200 or ABC dry powder extinguishers to extinguish the fire.
- Ask firefighters to avoid contacting with high-voltage components during extinguishing fires to prevent the risk of electric shock.
- Overheating may cause batteries to deform and leak corrosive electrolyte or toxic gas. Keep away from the batteries to avoid skin irritation and chemical burns.

2.8 Battery Recovery Process



- Dispose of used batteries in accordance with local laws and regulations. Do not dispose of batteries as household waste.
- If the batteries leak or are damaged, contact technical support or a battery recycling company for disposal.
- If the batteries are out of service life, contact a battery recycling company for disposal.
- Do not expose batteries to high temperatures or direct sunlight.
- Do not expose batteries to high humidity or corrosive environments.

3 Product Description

The HOME-ESS-LV-3.2K is a new generation equipment with home energy storage system that can meet the diverse needs of global users. High-performance lithium iron phosphate battery is used for functional integration and modular structure design. It has realized the convenient expansion, rapid product installation, load matching, remote control and many other functions.

Notes : The nominal current of the HOME-ESS-LV-3.2K product is 60 A. Please do not operate it under conditions exceeding this current. If the input or output current of the inverter connected to the battery exceeds 60 A, please use it in conjunction with the Hanchu combiner box.

3.1 Product Description

➤ 3.1.1 System Composition

The battery system consists of BMS and battery.

The battery consists of a high-performance lithium iron phosphate cell that can be charged and discharged to the load.

BMS(Battery Management System) is an intelligent electronic system that manages the charge and discharge of batteries and provides system safety protection.

➤ 3.1.2 Model Identification Description

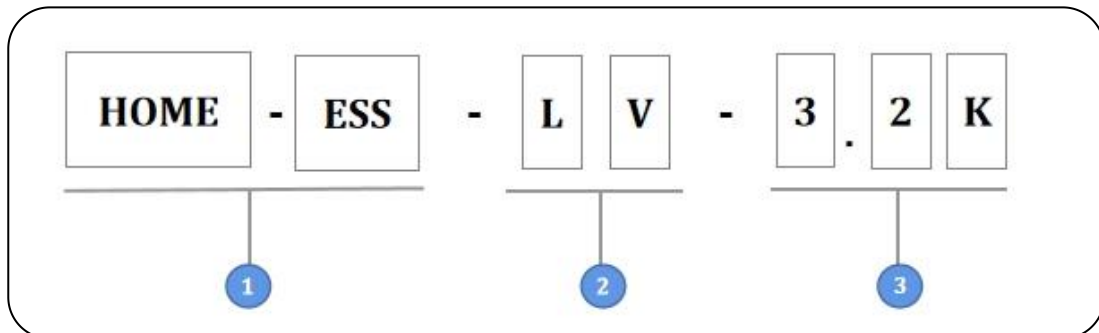

Figure 1 Name of the Product

Table 2 Definition of the Product Name

No.	Meaning	Value
1	Product	HOME-ESS: Home energy storage
2	Voltage strength	LV: Low Voltage
3	Battery sizes	3.2K: The battery capacity is 3.2kW·h

➤ 3.1.3 Product Dimension And Weight

Table 3 Product Dimension And Weight

Width	Depth	Height	Weight
484mm	165mm	302mm	34.9kg

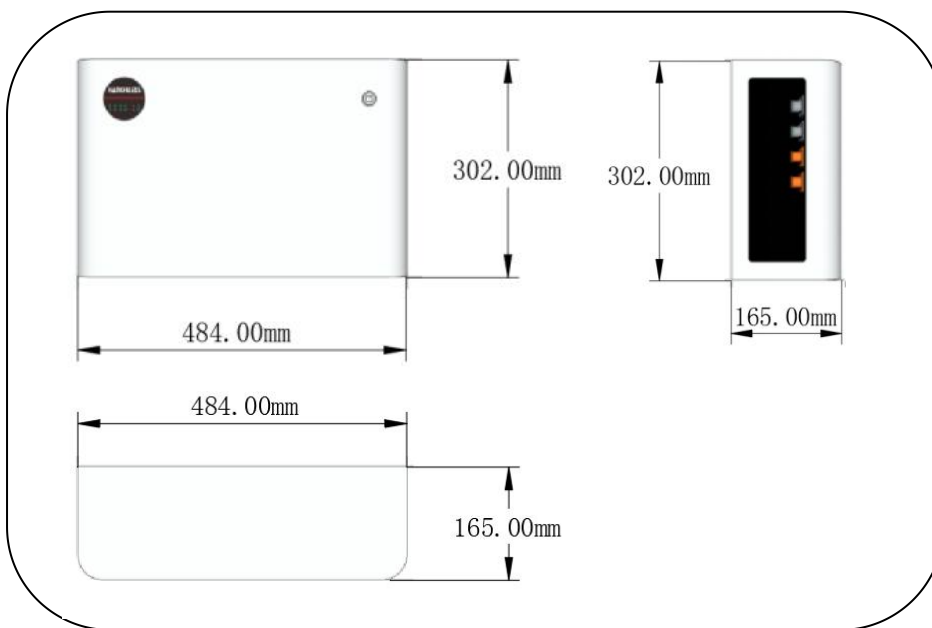

Figure 2 Picture of the Product

3.2 Interface Description

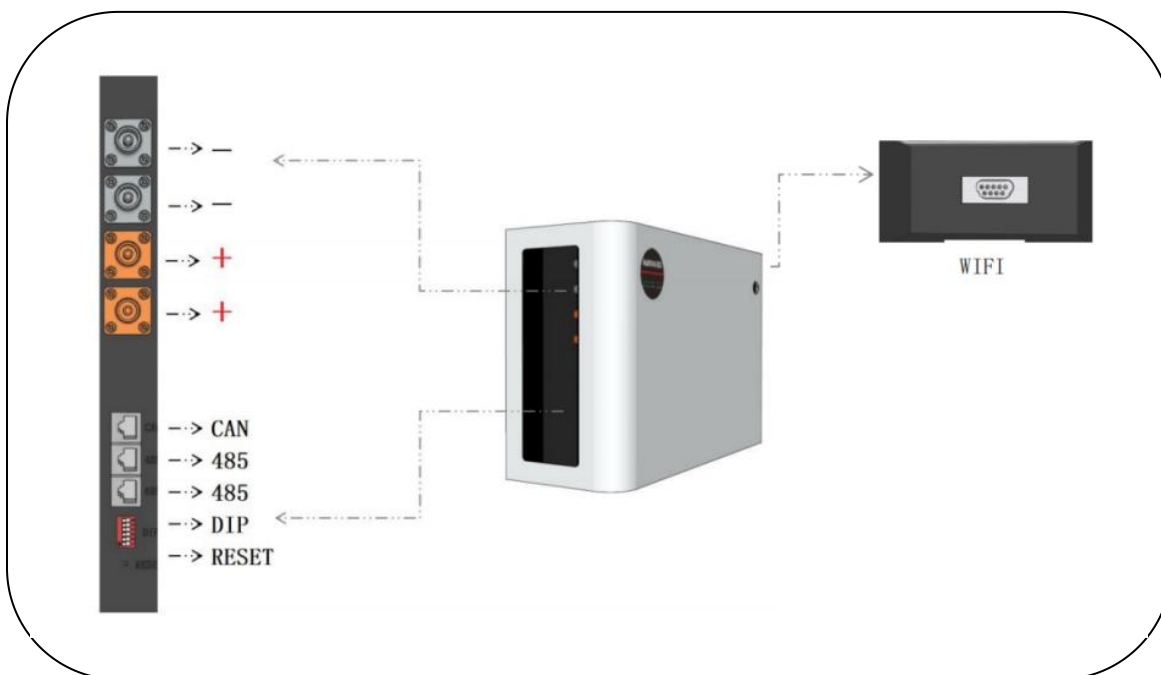









Figure 3 Interface Location Chart

3.3 Symbol Explanation

Table 4 Symbol Explanation

Symbol	Explanation
	The relevant equipment complies with the requirements in the CE guidelines.
	After the battery life is terminated, the battery can continue to be used after it recycled by the professional recycling organization and do not discard it at will.
	The scrapped battery cannot be put into the garbage can and must be professionally recycled
	The danger of electric shock!
	Follow the attached manuals
	Do not touch the product until 90 seconds after shutting down
	Hot surface
	Keep ventilated

➤ 3.3.1 Product Parameters

Table 5 Product Parameters

No.	Project	Parameter	Remark
1	Models	HOME-ESS-LV-3.2k	
2	Dimensions (mm) W*D*H	484*165*302	
3	Enclosure protection rating	IP54	
4	Module configuration	1 parallel 16 strings	1P16S
5	Nominal voltage (V)	51.2	
6	Operating voltage range (V)	43.2~57.6	
7	Nominal Energy (Wh)	3225.6	
8	Nominal discharge current (A)	60	
9	Max. discharge current (A)	65	
10	Nominal charge current (A)	40	
11	Max. charge current (A)	65	
12	Charge temperature range (°C)	0~50	
13	Discharge temperature range (°C)	-10~50	
14	Total weight (Kg)	34.9	
15	Communication interface	CAN/RS485/WIFI/Bluetooth	
16	Maximum parallel number	16	

4 Installation

4.1 Installation Note

Please read and understand this section carefully before installing the product!

➤ 4.1.1 Personnel Qualification

Product installers should have received safety technical training, obtained the local electrician certifications and the authorized qualifications for product installation. And installers should be familiar with electrical equipment, accumulate relevant experience and have the following capabilities, including but not limited to:

- Setup, startup, shutdown, grounding, short-circuiting and repair of electrical equipment.
- Standardized maintenance and use of protective tools for electrical equipment.
- Providing emergency assistance for the injured.
- Complying with local laws, regulations, standards and directives.

➤ 4.1.2 Installation Environment

Please make sure the installation location meets the following conditions:

- The building is designed to withstand earthquakes.
- The floor is flat and hard, and the area has minimal dust and dirt.
- The ambient environment is cool, dry, well-ventilated, and away from the sea, salt water, humid air, heat sources as well as direct sunlight.
- Temperature and humidity are kept at a constant level.
- There are no flammable and explosive items, corrosive gases, including ammonia and acid vapors, and contaminants.

Note: If the ambient temperature exceeds the operating range, the battery will stop working to protect itself. The optimal temperature range for battery operation is 15°C to 35°C. Frequent exposure to inappropriate temperature may reduce battery performance and life.

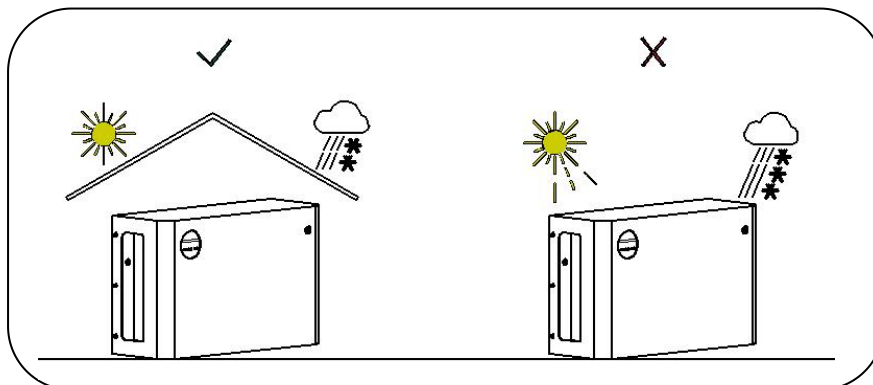

Figure 4 Sample of Installation Environment

➤4.1.3 Installation Angle

The battery can be installed on the ground or the wall. When the battery is installed on a wall, install it on a flat wall and keep the battery parallel to the wall. And don't install the battery at inclined, horizontal, or upside down positions.

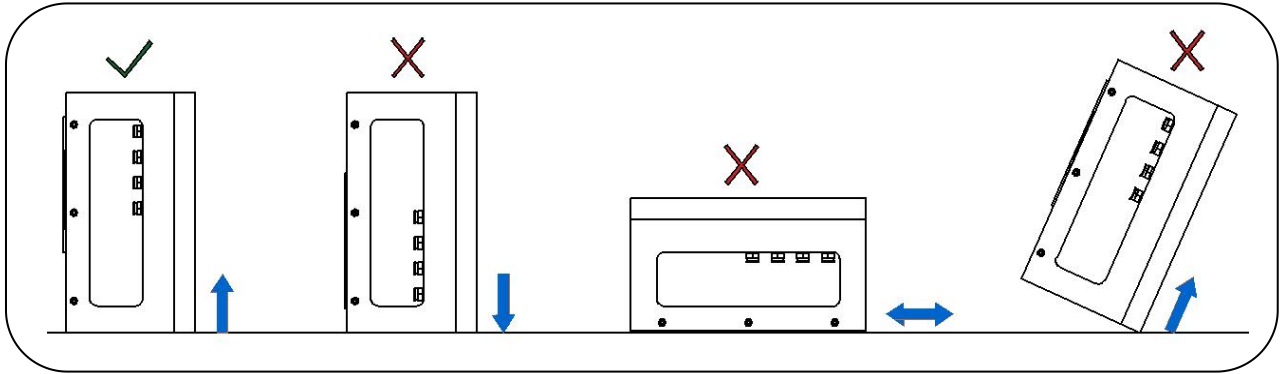

Figure 5 Sample of Installation Angle

➤4.1.4 Installation Space

Leave enough space to install the battery. When the battery is mounted on a wall, do not place any objects under the battery. Installation space as shown below.

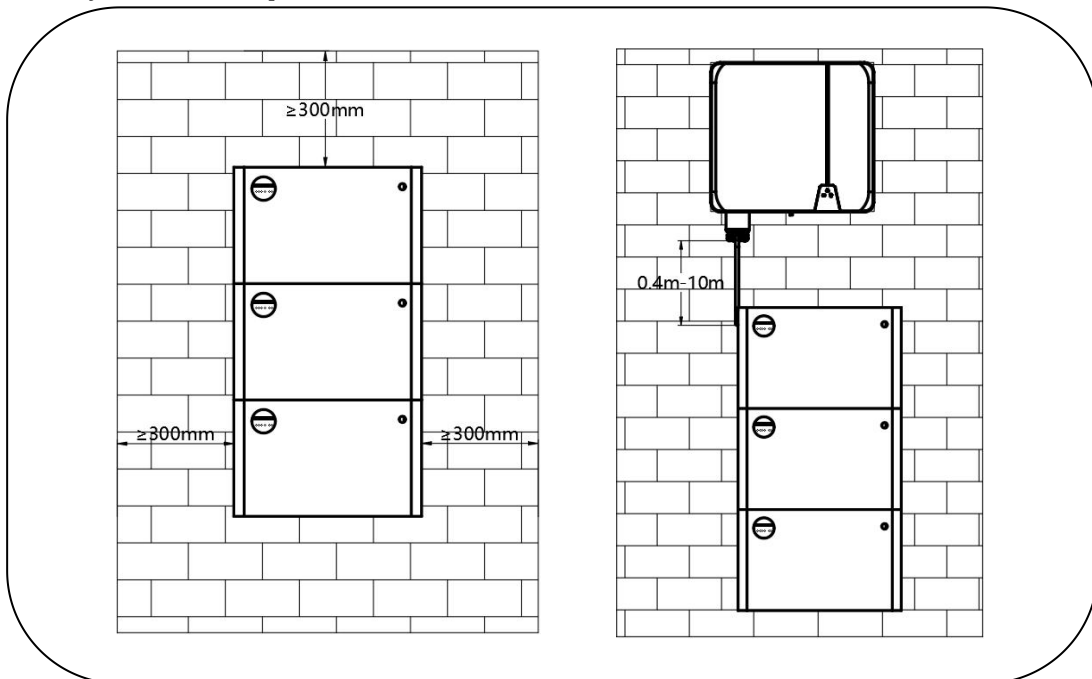

Figure 6 Installation Space diagram

4.2 Installation Preparation

➤4.2.1 Personal Protective Equipment

The product is a household energy storage system. Improper operation may cause personal injury and property damage.

Personal protective tools must be used during the installation.

The following are the recommended personal protective tools:

- Safety gloves: Prevent the risk of electric shock and scratches during the installation.
- Safety glasses: Prevent eye damage from splashing foreign objects during the installation.
- Safety Shoes: Prevent the risk of electric shock. Ensure safety in case the module is accidentally dropped during the installation.



Figure 7 Personal Protective Equipme

4.2.2 Installation Tools

Tools needed in the process of installing equipment, more effective to improve installation efficiency.

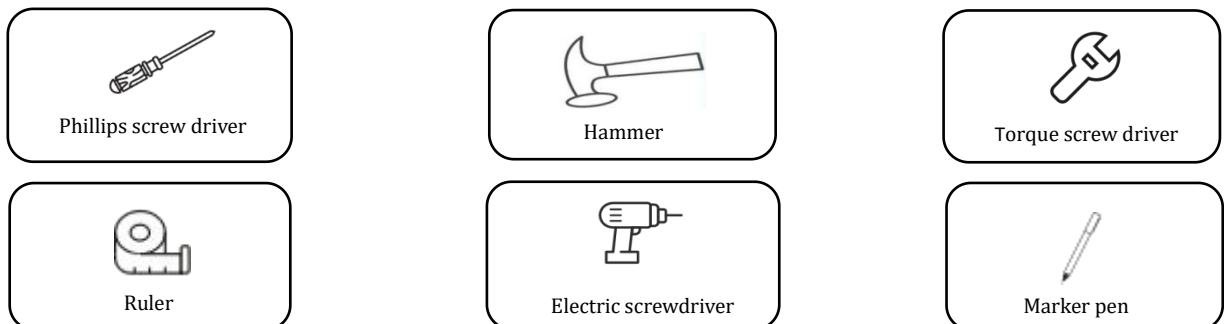

Figure 8 Installation Tools

➤4.2.3 Open Box To Check

- Make sure the battery is intact during shipping. If there is any visible damage such as cracks, please contact your dealer immediately.
- Tear off the packaging tapes to unpack the battery. Ensure that the battery packaging and all related items are in good condition.
- Please check the packing list carefully by referring to Section 4.2.4 Packing accessories. If there's any item missing, please contact your dealer directly.

4.2.4 Product Accessories

Table 6 Product Accessories

Label	Name	Quantity	Function description
A	Battery	1	System core components
B	Logger	1	System Status Monitoring
C	Power cable 1 Quick plug terminals at both ends/black/400mm	1	Connect the negative pole between the battery modules
D	Power cable 2 Quick plug terminals t both ends/red/400mm	1	Connect the positive pole between the battery modules
E	Power cable 3 Quick plug terminal+SC25-6- /black/1000mm	1	Connect the negative pole between the battery and the inverter
F	Power cable 4 Quick plug terminal+SC25-6 /red/1000mm	1	Connect the positive pole between the battery and the inverter
G	RS485 communication line/500mm	1	Connect the communication interface between battery modules
H	CAN communication line/1000mm	1	Connect the communication interface between battery and inverter
I	Metal bracket	1	Fix battery
J	Expansion tube/screw Diameter 6mm, depth 50mm	6	Fixed bracket
K	Ground screw/M4-6	1	Connected to ground terminal
L	Terminal/SC25-6	2	Spare terminals
M	Terminal/OT4-4	1	Connected to ground wire
N	Quick Installation Guide	1	Product installation guide

4.3 Installation

Make sure the ground is level and strong enough to bear the weight of products.

Before you start connecting cables, make sure that the inverter and battery are entirely switched off!

Make sure there is no water source above or near the battery, including downspouts, sprinklers, or faucets.

Step 1: Drill positioning holes on the wall

Use the bracket as a template to mark the position of the 6 hole, then drill 10mm wide holes and make sure the hole depth is more than 50mm.

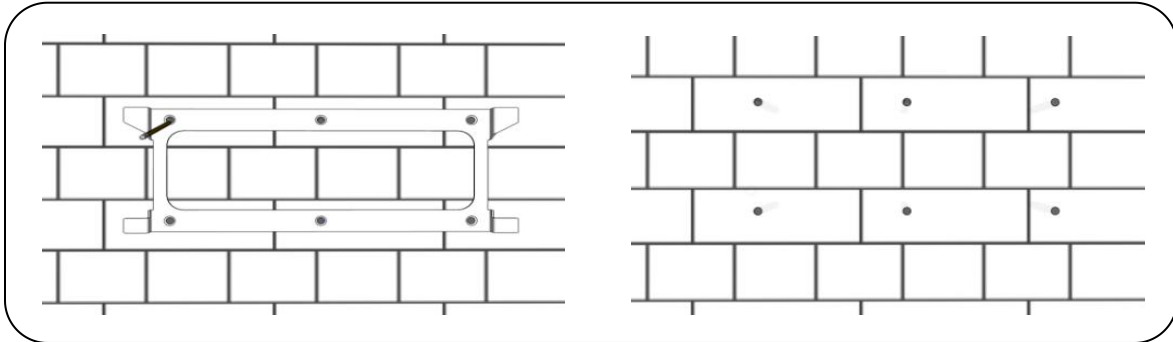

Figure 9 Sample of Step 1 For Wall Installation

Step 2: Fix the wall mount bracket

Fit the expansion tubes into the holes, pull them tight, and then use the expansion screws (packaged with expansion tube for use) to install and secure the wall mount bracket to the wall.

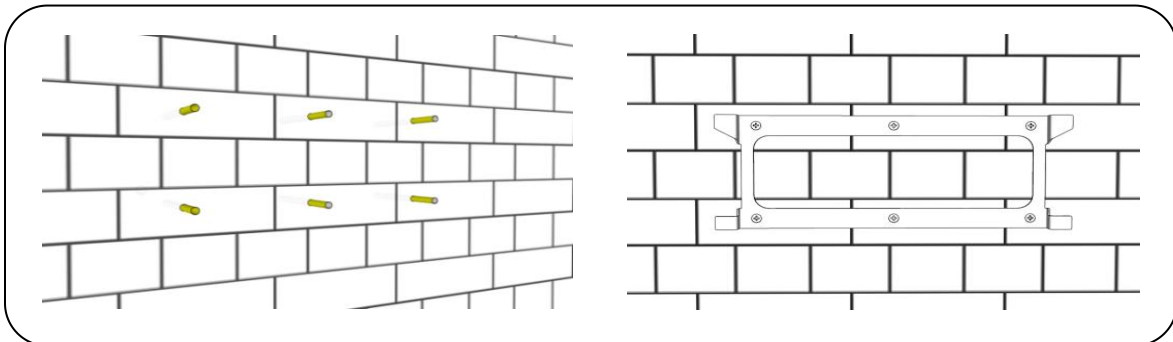

Figure 10 Sample of Step 2 For Wall Installation

Step 3: Fix the battery

There is a hook design on the back of the battery box, align and fix it to the positioning groove of the wall bracket for firm support.

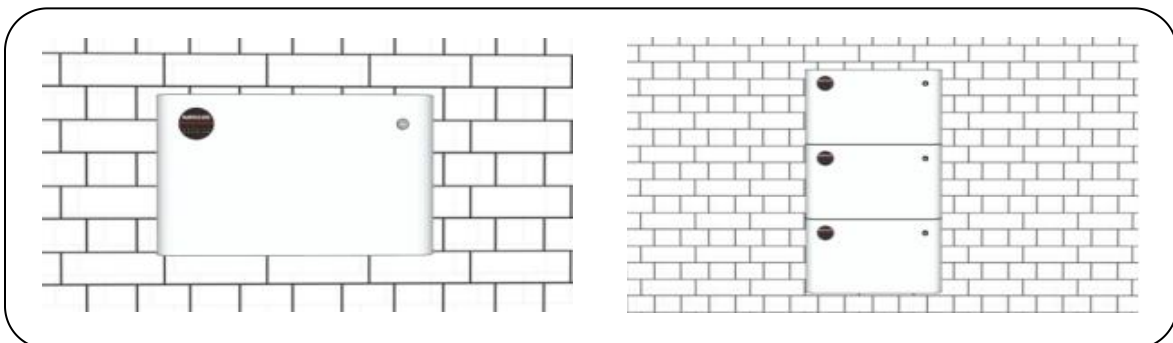

Figure 11 Sample of Step 3 For Wall Installation

4.4 Electrical Connections

Before connecting the cables, use a multimeter to measure cable continuity, short circuits, and verify positive and negative terminals and cable labelling.

➤4.4.1 System General Wiring Diagram

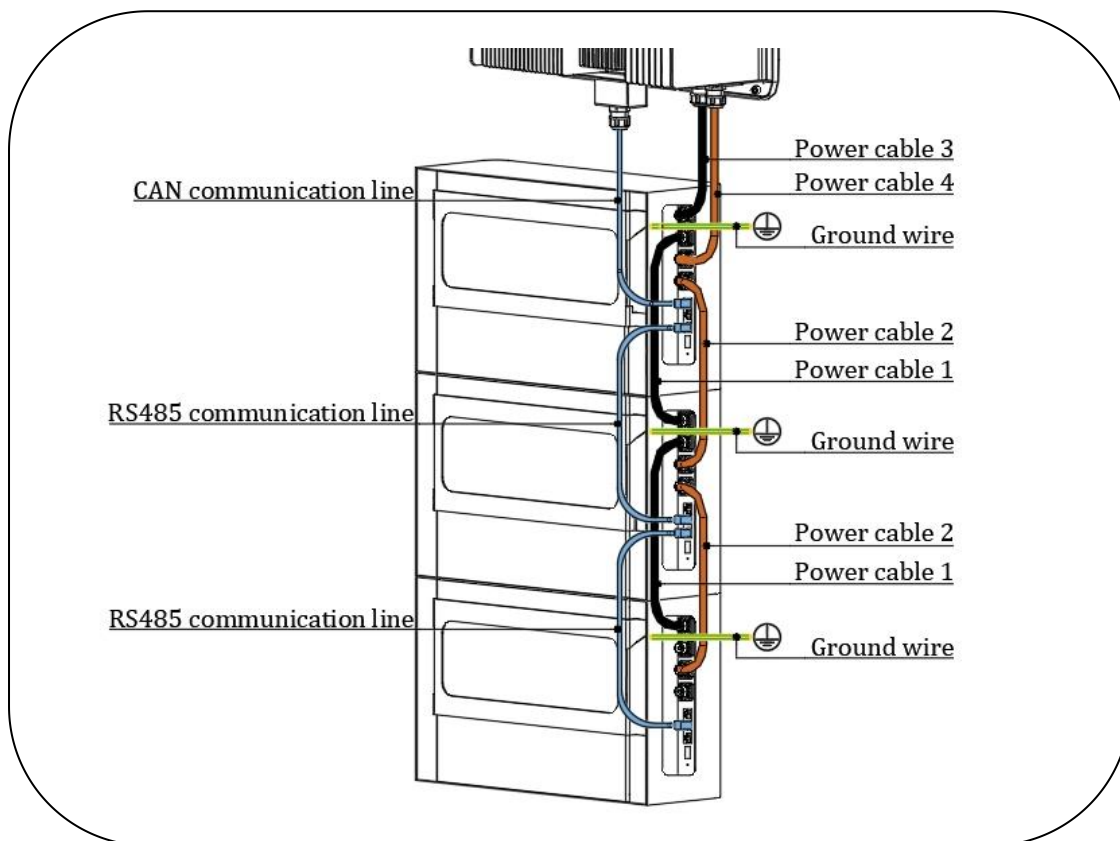

Figure 12 System General Wiring Diagram

4.4.2 Preparing Cables

Table 7 Cables Type

No.	Name	Function description	Size	Source
1	Ground wire	Ground the battery with a ground wire	4 mm ²	Prepared by the customer
2	Power cable 1	Connect the negative pole between the battery modules	Black 400mm	Delivered with the product
3	Power cable 2	Connect the positive pole between the battery modules	Red 400mm	Delivered with the product
4	Power cable 3	Connect the negative pole between the battery and the inverter	Black 1000mm	Delivered with the product
5	Power cable 4	Connect the positive pole between the battery and the inverter	Red 1000mm	Delivered with the product
6	RS485 communication line	Connect the communication interface between battery modules	500mm	Delivered with the product
7	CAN communication line	Connect the communication interface between battery and inverter	1000mm	Delivered with the product

4.4.3 Battery Ground Connection

1) Crimp the ground terminal

Customer needs to prepare the area of the grounding cable shall be at least 4mm², use a ground screw and terminal to connect the ground cable. The bolt locking torque is 6NM.

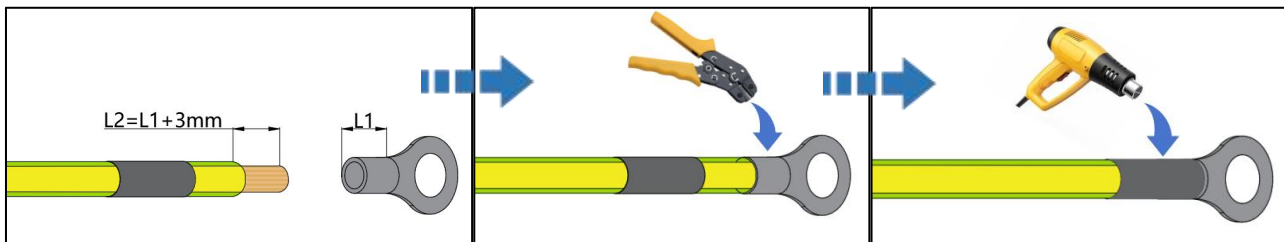

2) Ground the battery with a ground wire through the ground screw and terminal.

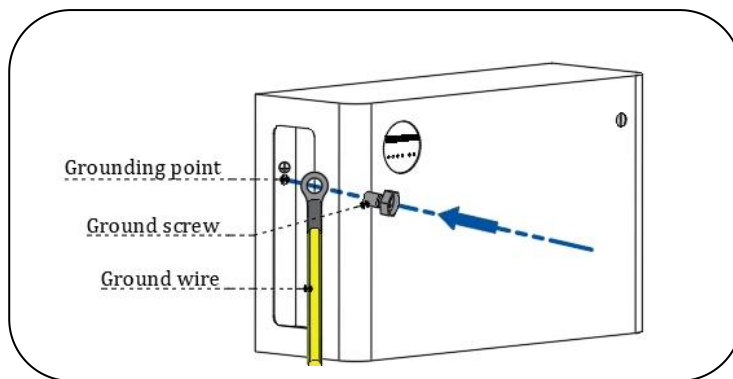

Figure 13 Sample of Battery Ground Connection

4.4.4 Power Connections Between Batteries

Use power cable 1 to connect the negative pole (P- terminal) of battery A to the negative pole (P- terminal) of battery B, and use power cable 2 to connect the positive pole (P+ terminal) of battery A to the positive pole (P+ terminal) of battery B.

For more than two battery connections, connect the negative poles (P- terminal) between the batteries and connect the positive poles (P+ terminal) between the batteries.

- 1) Connect the negative poles between batteries.
- 2) Connect the positive poles between batteries.

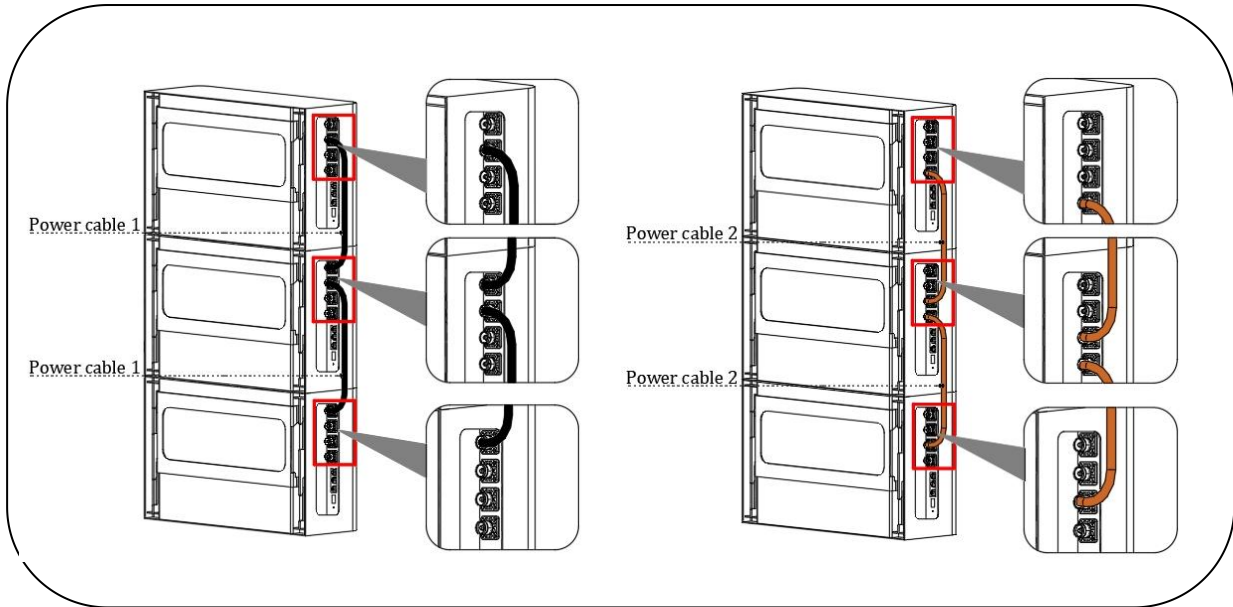

Figure 14 Sample of Power Connections Between Batteries

➤4.4.5 Connect The Primary Battery With The Inverter Through Power Cord

After the battery is connected according to Step 1-2, connect the negative pole (P- terminal) of the battery A and the BAT - terminal of the inverter with the power cable 3; connect the positive pole (P+ terminal) of the battery A and the BAT + terminal of the inverter with the power cable 4.

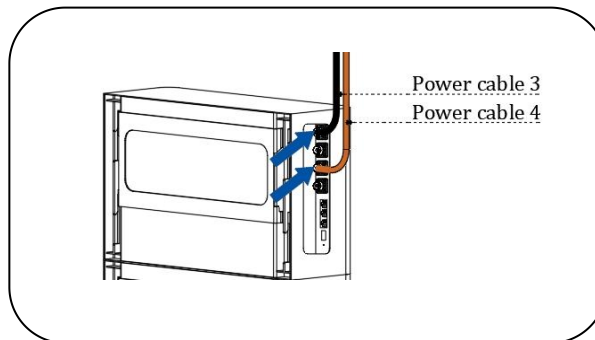

Figure 15 Sample of Power Cable Connection Between the Battery And Inverter

Note :

Before connecting the inverter electrically, the inverter and batteries need to be powered off.

It is forbidden to mix batteries of different brands, specifications and batches, otherwise it will cause system failure.

4.5 Communication Connection

➤4.5.1 Connect The CAN Communication Cable

Use the CAN communication cable to connect the inverter with the primary through CAN protocol.

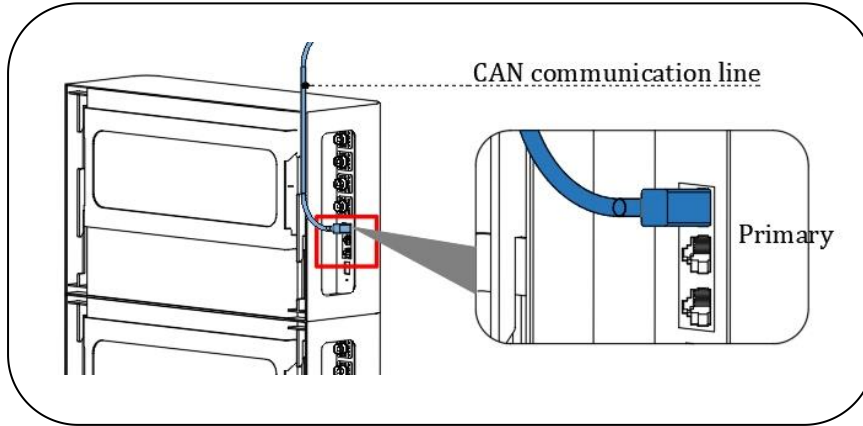

Figure 16 Sample of Connection the CAN Communication Cable

➤4.5.2 Connect The RS485 Communication Cable

Use the RS485 communication cable to connect the battery in sequence through the RS485 port.

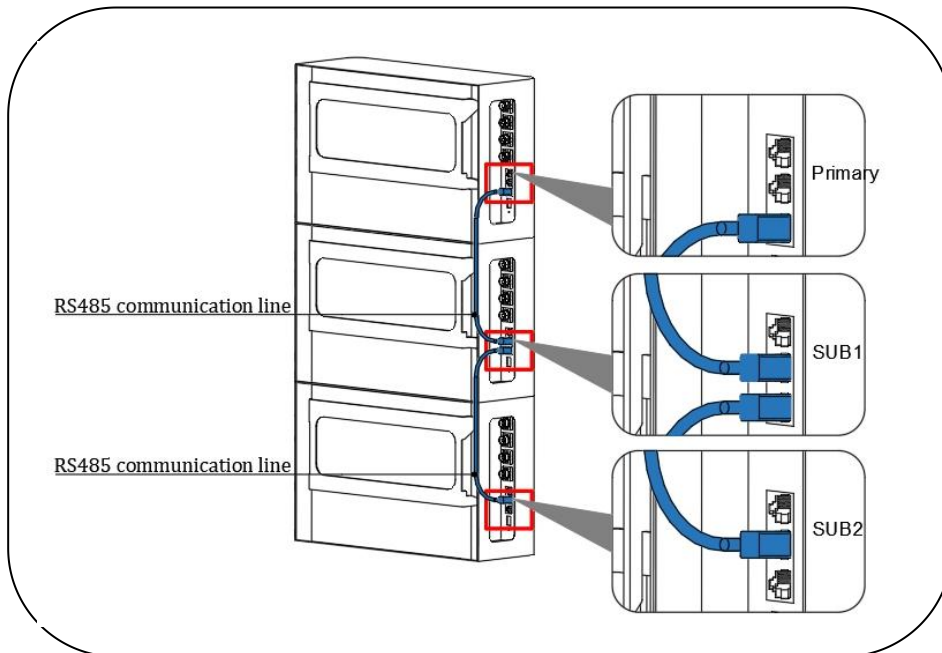

Figure 17 Sample of Connection the RS485 Communication Cable

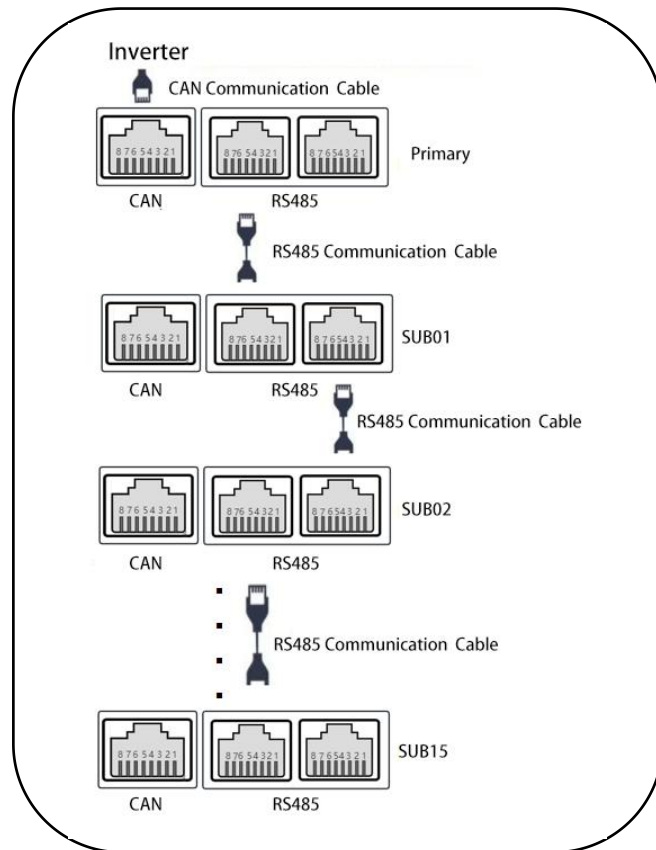

Figure 18 Sample of Communication Parallel

Note:

- 1) The connection between the inverter and the battery must be connected to the CAN communication port of the battery, otherwise communication cannot be performed; the connection between the batteries must be connected to the RS485 port.
- 2) The communication port pins connecting the primary to the inverter are defined as follows:

Table 8 Definition of CAN Port Pins

	CAN port	
	RJ45 Pins	Definition
	4	CANH
	5	CANL
	6	GND
1、2、3、4、7、8	NC	

3) The communication port pins connecting the subs to the primary are defined as follows:

Table 9 Definition of RS485 Port Pins

	RS485 port	
	RJ45 Pins	Definition
	1、 8	RS485_B
	2、 7	RS485_A
	3、 6	GND
4、 5	NC	

4.6 Equipment Debugging

Definition of DIP code: #1-#4 are address bits ,#5 is communication protocol bit and #6 is primary bit.

#1	#2	#3	#4	#5	#6
Address Bits			Communication Protocol Bit		Primary Bit
Binary 0~15 bit address			Agreement brand definition according to chapter 4.6.3		

➤ 4.6.1 Primary And Subordinate DIP Address Setting

The battery directly connected to the inverter is the primary and the rest are subordinates.

The address allocation principle is binary. The battery address setting in the same system cannot be repeated.

Primary DIP setting: DIP address is (6:ON, 1-5:OFF), the battery factory default settings are the master mode and don't need to be changed.

Subordinate DIP setting: Dip address is #1-#4 , #5 need to be dipped OFF.

The DIP Address of primary and subordinate units are set according to the table below:

Table 10 DIP Address Settings

No.	Address Settings	DIP ON	DIP OFF	UNIT
0		/	1、 2、 3、 4、 5、 6	SUB
1		1	2、 3、 4、 5、 6	SUB
2		2	1、 3、 4、 5、 6	SUB

3		1, 2	3, 4, 5, 6	SUB
4		3	1, 2, 4, 5, 6	SUB
5		1, 3	2, 4, 5, 6	SUB
6		2, 3	1, 4, 5, 6	SUB
7		1, 2, 3	4, 5, 6	SUB
8		4	1, 2, 3, 5, 6	SUB
9		1, 4	2, 3, 5, 6	SUB
10		2, 4	1, 3, 5, 6	SUB
11		1, 2, 4	3, 5, 6	SUB
12		3, 4	1, 2, 5, 6	SUB
13		1, 3, 4	2, 5, 6	SUB
14		2, 3, 4	1, 5, 6	SUB
15		1, 2, 3, 4	5, 6	SUB

32		6	1、2、3、4、5	Primary
48		5、6	1、2、3、4	Primary

➤ 4.6.2 Equipment Power On

After confirming that the cables are connected in the correct order and the connections are tight, the system is powered on and activated the system in the following order:

- 1) Press the battery power switch in turn (first the master, then the slave 01~15) to start the battery.
- 2) Observe whether the status of the indicator light on the battery panel is normal ('RUN' green light flash, 'ALM' light off). Indicator light is normal can continue in order to power on. If the indicator light is faulty, you need to remove the fault and then power on.
- 3) Close the circuit breaker between the battery and the inverter.
- 4) The power-up process of the inverter is carried out according to the manual process of the inverter.

➤ 4.6.3 Inverter Protocol Selection

The battery default factory CAN communication is Hanchu ESS protocol.

Protocol selection:

- 1) Check which protocols are supported by the inverter.
- 2) If the inverter supports the battery factory default protocol, select the corresponding protocol on the inverter directly.
- 3) If the inverter supports protocols other than the battery factory default protocol, select the same protocol on the battery and the inverter.

Battery protocol selection: select the protocol in the #5 position of the primary DIP Address.

Table 11 DIP Address Settings for Communication

Primary unit	DIP ON	DIP OFF	Inverter brands
	6	1、2、3、4、5	HanchuESS(default)、 Luxpower
	5、6	1、2、3、4	Deye、Pylon

➤ 4.6.4 Equipment Power Down

After confirming that the load is off and the battery has stopped charging and discharging, power down in the following order:

- 1) Disconnect the circuit breaker on the battery and the circuit breaker between the battery and the inverter.

- 2) Turn off the power switch on the battery.
- 3) Indicator light goes out.

If the battery is not working after a long period of time, it is necessary to maintain and recharge the battery in time according to subsections 6.2 and 6.3 of this manual.

➤ 4.6.5 *Logger Installation*

Step 1: Registering and login

Tap "Sign up", after filling in the information, click on "Confirm" to log in.

If you have already registered, you can tap "Sign in" in directly as shown in Fig. 19.

Step 2: Create station

Tap " Create station " on the page, as shown in Fig. 20. You will need to fill in information for the new station, as shown in Fig. 21.

If you have a station, but need to add new devices to your station. Please tap the "+" button to add devices to your station, as shown in Fig.22.

Step 3: Network Connection

Select the WiFi network you want to connect to, enter your WiFi password and tap "Confirm", as shown in Fig.23.

Step 4: Bluetooth search

Turn on your phone's Bluetooth, then select the devices you want to bind. Tap "Bind with station" to bind the devices to your station, as shown in Fig. 24. The SN on this page is the same as the SN on the logger. After the devices are connected to the network and bound successfully, you will see the page shown in Fig. 25.

Step 5: Bluetooth search

Please tap the "Go back". Now you can use the APP to view your device data.

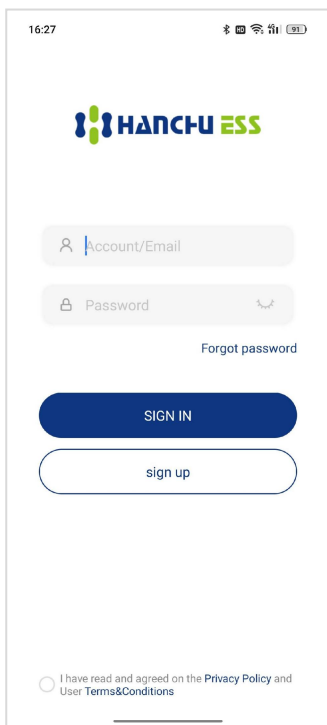

Figure 19

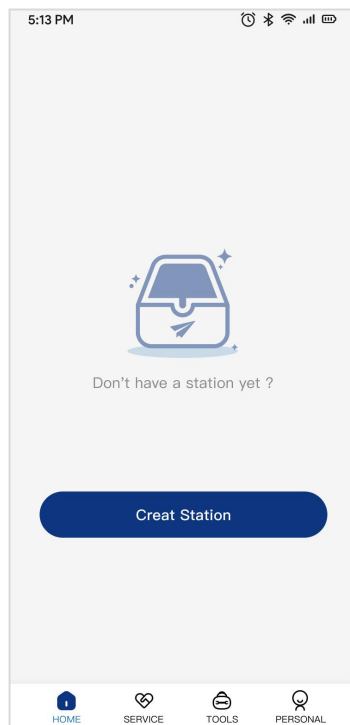

Figure 20

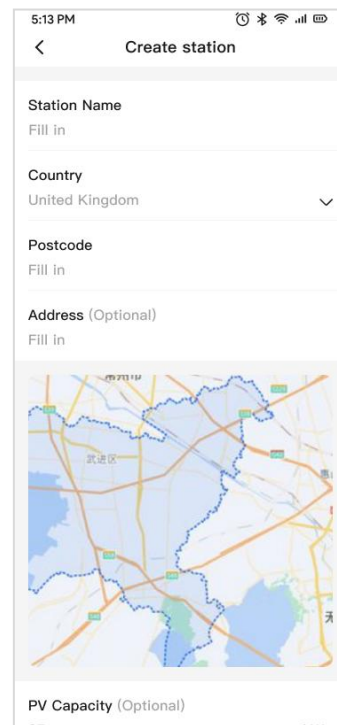

Figure 21

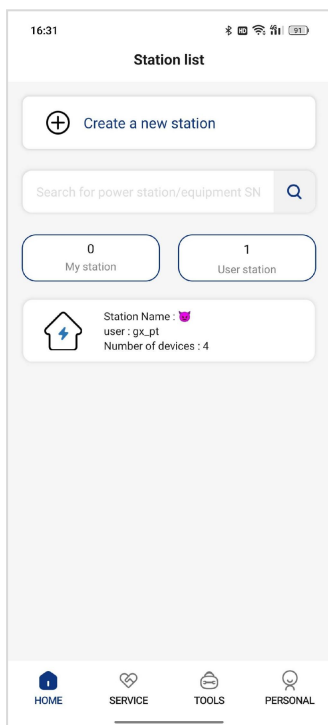

Figure 22

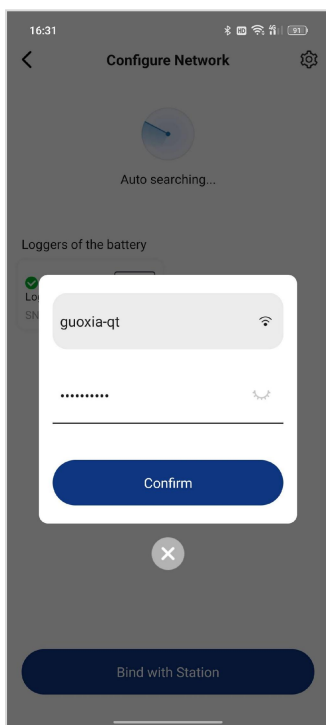

Figure 23

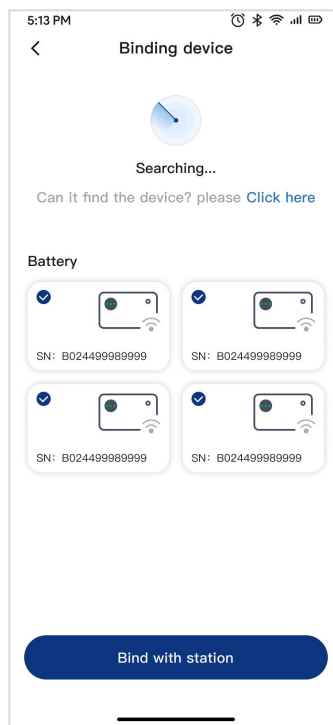

Figure 24

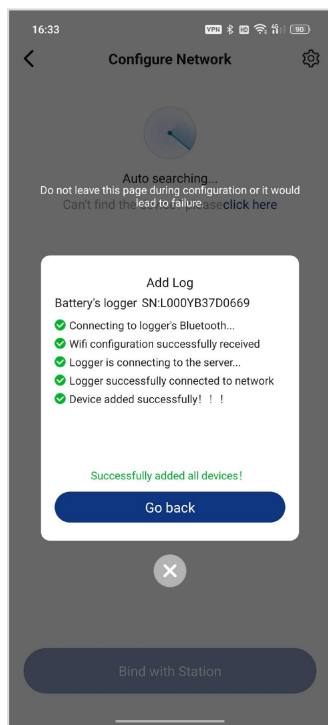

Figure 25

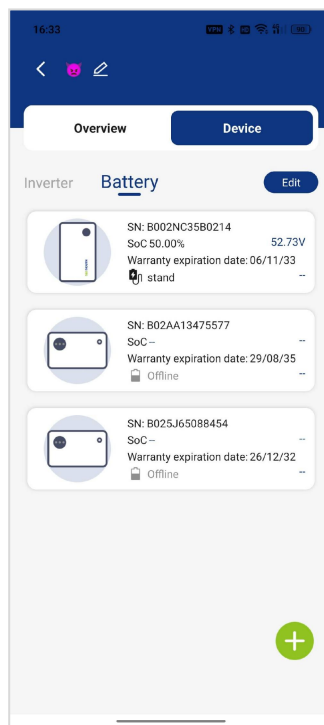

Figure 26

Please refer to the attached Monitor Usage Guide for the installation and registration of the logger.



Figure 27 Sample of the Logger and Usage Guide

4.7 Definition of Indicator Lights

The indicator light consists of 6 lights, the first 4 lights indicate the SOC of the battery, which are 25%, 50%, 75% and 100% respectively. The fifth 'ALM' light (Red light) is a fault indicator, which will light up when the system has a fault. The sixth 'RUN' light is the normal operation light, and the green light will light up when the system is operating normally. When the system shuts down, all lights go out.

➤ 4.7.1 Capacity Indicator

The definitions of the indicator lights during the charging and discharging process of the battery are shown in the following table.

Table 12 Definition of the Indicator Lights

State	Charge				Discharge			
capacity indicator	SOC4●	SOC3●	SOC2●	SOC1●	SOC4●	SOC3●	SOC2●	SOC1●
0~25%	FLASH 2	OFF	OFF	OFF	ON	OFF	OFF	OFF
25~50%	ON	FLASH 2	OFF	OFF	ON	ON	OFF	OFF
50~75%	ON	ON	FLASH 2	OFF	ON	ON	ON	OFF
75~100%	ON	ON	ON	FLASH 2	ON	ON	ON	ON
Running lights	ON				FLASH 3			

➤ 4.7.2 Status Indicator

Table 13 Definition of the Status Indicator

State	Abnormal event	LED				ALM	RUN
		●	●	●	●	●	●
Shutdown	Shutdown	ALL OFF				OFF	OFF
Standby	Normal	According to the battery indicator				OFF	FLASH 1
	Alert					FLASH 2	FLASH 1

Charge	Normal	According to the battery indicator Highest indicator LED flash 2	OFF	ON
	Alert		FLASH 2	ON
	Overvoltage protection/Full charge protection	According to the battery indicator	OFF	ON
	Overcurrent protection (limited current charging)	According to the battery indicator(Flashing twice when there is charging current)	OFF	ON
	Temperature protection	ALL OFF	ON	OFF
Discharge	Normal	According to the battery indicator	OFF	FLASH 3
	Alert	According to the battery indicator	FLASH 2	FLASH 3
	Undervoltage protection	According to the battery indicator	FLASH 2	OFF
	Overcurrent, short circuit protection	ALL OFF	ON	OFF
	Temperature protection	ALL OFF	ON	OFF
Fault	NTC fault, MOS fault, reverse connection, differential pressure protection, ultra-low voltage protection	ALL OFF	ON	OFF

➤ 4.7.3 Flashing Description

Table 14 Flashing Description

Flashing method	ON	OFF
Flash once	0.25s	3.75s
Flash twice	0.5s	0.5s
Flash three times	0.5s	1.5s

5 Common Troubleshooting

Table 15 Common Troubleshooting

Accident	Fault description	Solution
Indicator light does not come on	Indicator light does not light up when button is pressed.	Long press the power switch 2s to restore. If the long press does not work, please contact the Hanchu ESS after-sales service department or your dealer directly.
No DC Output	Charging and discharging cannot be realised after connecting to the power supply.	Check whether the circuit breaker at the battery terminal is closed and switched on. If it is closed and charging/discharging is still not possible, please contact Hanchu ESS after-sales service department or your dealer directly.
External Communication Errors	The communication interruption between BMS and inverter.	Check if the communication cable between BMS and inverter is correct and well connected.
Internal Communication Errors	1. The DIP switch is at the wrong position; 2. The communication lost between batteries.	1. Move the DIP switch to the correct position; 2. Check if the communication cable between the batteries is correct and well connected.
Over Voltage Alarm	Battery voltage is too high .	Wait for the battery voltage to return to normal.
Lower Voltage Alarm	Battery voltage is too low.	Please contact Hanchu ESS after-sales service department or your dealer directly.
Charge OCP	Battery charging over current protection.	Please contact Hanchu ESS after-sales service department or your dealer directly.
Discharge OCP	Battery discharge over current protection.	Please contact Hanchu ESS after-sales service department or your dealer directly.
High Temperature Protection	Battery temperature is too high.	Wait for the cell temperature to return to normal.
Low Temperature Protection	Battery temperature is too low.	Wait for the cell temperature to return to normal.
Cell Imbalance	The capacity of the battery is different.	Please contact Hanchu ESS after-sales service department or your dealer directly.
MOS Protection	Battery hardware is under protection.	Please contact Hanchu ESS after-sales service department or your dealer directly.

Insulation Fault	Battery insulation failure.	Stop using, Please contact Hanchu ESS after-sales service department or your dealer directly.
VoltSensor Fault	Battery voltage sensor failure.	Please contact Hanchu ESS after-sales service department or your dealer directly.
TempSensor Fault	Battery temperature sensor failure.	Please contact Hanchu ESS after-sales service department or your dealer directly.
Temperature difference alarm	The temperature between cells are different.	Stop charging and discharging. Please contact Hanchu ESS after-sales service department or your dealer directly.

6 Battery Maintenance

6.1 Battery Storage Requirements

The battery is required to be stored in a temperature range from 0°C to +40°C. Routine maintenance is required for batteries that have been stored for a long time. Depending on the storage time of the battery and the storage environment, Please charge the battery to the corresponding SOC at 0.2C as required by the table below.

Table 16 Battery Storage Requirements

Ambient temperature	Relative humidity in storage environment	Storage time	SOC
<0°C	/	Prohibited	/
0~40°C	5%~60%	≤1month	15%≤SOC≤40%
5~35°C		≤6month	30%≤SOC≤60%
>45°C	/	Prohibited	/

- After a long-time storage, the battery should be inspected and tested by professionals before use.
- During the storage period, record temperature, humidity and storage environment in accordance with storage requirements in this manual.
- Long-term storage of batteries is not recommended, which will cause capacity loss. Generally, after 12 months of storage at the recommended storage temperature, an irreversible capacity loss of lithium batteries is 3%~10%.
- The batteries should be stored in accordance with the labels on the packaging box and should not be inverted or placed sideways.
- The battery boxes should be stacked according to the stacking requirements on the outer packaging.
- When handling the battery, take care not to damage the battery.
- Storage Environment Requirements :
 - Ambient temperature: short-term storage (less than 1 month)0°C~40°C, long-term storage (more than 1 month)5°C~35°C. Recommended storage temperature: 20°C~30°C.
 - Relative humidity: 5%RH~60%RH.
 - Store products in a dry, clean and ventilated place. Keep them away from dust, direct sunlight, rain, vapor or groundwater.
 - Avoid contact with corrosive organic solvents, gases and other substances.

6.2 Charging Requirements After Over-discharge

The battery stops discharging there is still static power consumption of the internal battery module and its own self-discharge loss, if there is no charge for a long time to replenish, it may lead to battery damage due to over-discharge. When the battery SOC is low, it needs to be replenished according to the maximum interval in the following table.

Table 17 Lithium Battery Recharge Cycle

SOC at power down before storage	Maximum recharge interval
SOC<5%	24h

We do not provide warranty service for permanent battery failure due to overdue recharging by the customer.

6.3 Long-term Idle Maintenance Requirements

If a long period of inactivity (≥ 30 days) is planned, the following two requirements should be observed to protect the battery:

- 1) Ensure that the battery's SOC system is above 30% and that the battery circuit breaker and power switch remain off.
- 2) If it is stored for more than 30 days, due to different temperature and different storage time, it has different effects on self-discharge. Therefore, before the batteries go online, it is necessary to check the voltage completely to confirm the necessity of maintaining the state of charge, our company can assist the customer to make a judgment.
- 3) If the interval between two charges of the battery exceeds 2 months, the standard charging mode should be adopted for 2~3 times before the the battery performance can reach the best state.
- 4) If it is stored for more than 3 months, it shall be tested and maintained every 3 months. If it is not tested or maintained for more than 9 months, Hanchu will not be responsible for quality protection for capacity loss or other defects caused by batteries.

Note: We do not provide appropriate warranty service for permanent battery failure due to improper storage by the customer.

6.4 Battery Maintenance Safety Requirements

When the equipment is running, a high voltage may cause electric shocks and result in death, serious injury or property damage. Before performing maintenance, turn off the equipment and strictly follow the safety precautions listed in this manual and other related documents.

- Ensure that you are familiar with the contents of this manual and have appropriate tools and test equipment to perform maintenance.
- Before performing maintenance, turn off the equipment according to the instructions and wait for a certain period of time to ensure that the equipment is power-off .
- During maintenance, prevent unnecessary personnel from getting close to the maintenance site. Temporary warning signs or fences must be erected to isolate the site.
- If the equipment fails, please contact your dealer in time to deal with it.
- The equipment can only be power-on again after the fault has been dealt with. Otherwise, the equipment may have some problems or become damaged.
- Do not disassemble the product without authorization. There is a danger of electric shocks and the corresponding failure is not covered by the warranty.
- Maintenance personnel should have received the professional training and use protective tools to conduct maintenance.
- When it is necessary to move or rewire, the input power must be cut off. Wait for 5 minutes to ensure that the internal energy of the machine has been discharged. The maintenance should be started after

confirming with a multimeter that there is no dangerous voltage and no parts need to be repaired inside the machine.

- Maintenance of batteries should be performed or supervised by someone who is familiar with batteries and required precautions.

- Please use the same type of cell when replacing cells.

- After maintenance, immediately check that no tools or other parts have been left inside the equipment.

- If the equipment has not been used for a long time, you need to store and charge the battery according to this manual.

All operators of the energy storage system shall comply with the user manual. Any equipment damage caused by neglecting or misreading the user manual, will void the product warranty.



Android APP



iOS APP

Jiangsu Hanchu Energy Technology Co., Ltd

No.9, Huicheng Road, Huishan District, Wuxi City, Jiangsu
Province, China

Hotline:+86-51088876668/+86-51088865288

Email:service@hanchuess.com

Web:www.hanchuess.com